

FELCO 6 - Verde

Forbice da potatore - Elevate prestazioni - Ergonomico - Compatto

Made in Switzerland by FELCO



20mm/0.8in.



M



L



195mm/7.7in. 210g/7.4oz.



> **Affidabilità:** impugnature comode, leggere e solide, in alluminio forgiato, garantite a vita* / lama e controlama avvitata in acciaio temperato di elevata qualità / taglio netto e preciso / tutti pezzi sostituibili

> **Efficacia:** regolazione facile e durevole del taglio / tagliafilì / scorrisuoco

> **Ergonomia:** protezione della mano e del polso grazie alla forma ideale delle impugnature e al battente-ammortizzatore / rivestimento antiscivolo

CONSIGLIATO PER

Il nostro consiglio (★ = Consigliato, ★ ★ = Fortemente consigliato, ★ ★ ★ = Scelta migliore)

Viticoltura	★ ★ ★
Frutticoltura	★ ★ ★
Orticoltura	★ ★ ★
Parchi e giardini	★ ★ ★
Vivaio	★ ★ ★
Mano piccola	★ ★ ★
Mano media	★ ★ ★
Mano grande	★ ★ ★
Per destrorsi	★ ★ ★
Mancino	★ ★ ★

I MARCHI D'ECCELLENZA



Tagliafili

Le lame sono dotate di una tacca per il taglio del fil di ferro di piccolo diametro, senza danneggiare la lama stessa.



Scorrisucco

L'asciuga lama permette di tagliare vegetali, senza rischi di incollaggio della lama. Si risparmia tempo e si facilita il taglio, eliminando lo sporco e la linfa dopo ogni taglio.



Regolazione micrometrica

Il dispositivo di regolazione di precisione FELCO garantisce per tutta la vita dell'attrezzo una regolazione ottimale della testa di taglio, permettendo un taglio netto e preciso.



Sistema di ammortizzamento

Il battente e l'ammortizzatore riducono gli urti alla fine del taglio, proteggendo così la mano e il polso.



Impugnature in alluminio forgiato

Leggerezza, robustezza e rigidità grazie ad una lega di alluminio e al processo di sagomatura del materiale con stampaggio di precisione perfettamente controllato da FELCO. Parti garantite a vita*.

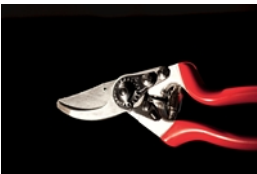

Testa di taglio inclinata

Per ridurre i rischi di disturbi muscolo-scheletrici ed aumentare la comodità d'uso, la testa di taglio risulta inclinata.

ACCESSORI



FELCO 902
Strumenti per l'affilatura
Pietra per affilare



FELCO 903
Strumenti per l'affilatura
Affilatoio



FELCO 910
Astucci
In cuoio - Con passante e clip a
molla



FELCO 912
Astucci
In cuoio - Con clip a molla











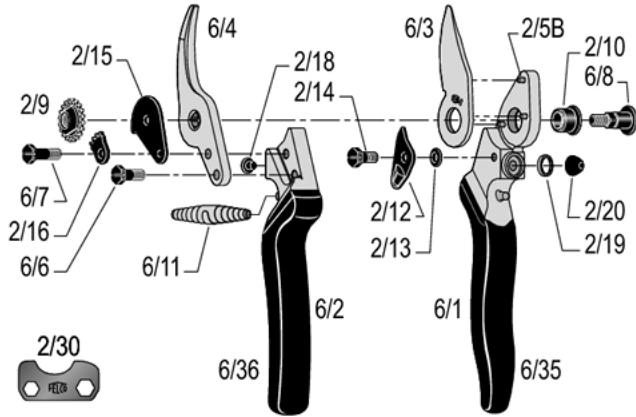









FELCO 980
Prodotti per manutenzione
Spray

































FELCO 990
Prodotti per manutenzione
Grasso

RICAMBI



FELCO	RIF.	Descrizione	Composizione	Codice a barre UCC
	2/30	Chiave di regolazione	1x 2/30	 7 83929 40163 8
	2/92B	Kit	1x 2/14 + 1x 2/12B + 2x 2/13	 7 83929 40392 2
	6/3	Lama	1x 6/3	 7 83929 40003 7
	6/3-1	set	1x 6/3 1x 6/11 1x 2/30	 7 83929 40417 2
	6/4	Controlama con vite	1x 6/4 + 1x 6/6	 7 83929 40011 2
	6/90	Kit	1x 6/7 + 1x 2/16 + 1x 2/9 + 1x 6/8	 7 83929 40016 7
	6/91	Kit	2x 6/11	 7 83929 40019 8
	2/92	Kit	1x 2/15 + 1x 2/18 + 1x 2/14 + 1x 2/12 + 1x 2/13 + 1x 2/20	 7 83929 40020 4
	2/93	Kit	4x 2/18 + 6x 2/20	 7 83929 40021 1

	6/94	Kit	1x 2/9 + 1x 6/8	 7 83929 40027 3
	6/1	Manico senza lama	1x 6/1 + 3x 2/5B + 1x 2/19 + 1x 2/20 + 1x 2/10 + 1x 2/13 + 1x 2/12 + 1x 2/14 + 1x 6/35	 7 83929 40216 1
	6/2	Manico senza controlama	1x 6/2 + 1x 2/18 + 1x 6/36	 7 83929 40218 5
	6/35	Rivestimento per portalama	1x 6/35	 7 83929 40219 2
	6/36	Rivestimento per manico controlama	1x 6/36	 7 83929 40220 8
	2/5B	Ribattino per lama	1x 2/5B	 7 83929 40166 9
	6/6	Vite per controlama	1x 6/6	 7 83929 40221 5
	6/8	Bullone	1x 6/8	 7 83929 40223 9
	2/9	Dado dentato	1x 2/9	 7 83929 40169 0
	2/10	Boccola	1x 2/10	 7 83929 40151 5
	6/11	Molla nichelata	1x 6/11	 7 83929 40217 8
	2/12	Chiusura	1x 2/12	 7 83929 40153 9
	2/13	Ranella per chiusura	1x 2/13	 7 83929 40154 6
	2/14	Vite per chiusura	1x 2/14	 7 83929 40155 3
	2/15	Placca di base	1x 2/15	 7 83929 40156 0

	2/16	Settore dentato	1x 2/16	
	6/7	Vite per settore dentato	1x 6/7	
	2/18	Battente	1x 2/18	
	2/19	Anello di fissaggio	1x 2/19	
	2/20	Ammortizzatore	1x 2/20	

MANUTENZIONE



Pulizia

Vi consigliamo di pulire il vostro attrezzo dopo ogni utilizzo.
Se il vostro attrezzo è particolarmente sporco o suscettibile alla ruggine dopo essere stato esposto all'umidità, non posticipatene la pulizia.



Lubrificazione

Dopo la pulizia, vi consigliamo di oliare l'attrezzo per proteggerlo dalla corrosione. L'olio permette inoltre di sbloccarlo in caso d'inceppamento.



Affilamento

Vi consigliamo di affilare il vostro attrezzo almeno una volta al giorno, ma se pensate che non tagli più come prima, affilatelo subito!



Smontaggio

Vi consigliamo di smontare regolarmente il vostro attrezzo, e al più tardi quando vi sembra che si sia inceppato.

SOSTITUZIONE DI PEZZI



Sostituzione della lama

Se la lama e la controlama non s'incrociano più, o se la lama è troppo danneggiata, vi consigliamo di cambiarla.

Calibrate il gioco della lama e della controlama regolando la forza di serraggio del dado. La lama deve sfregare contro la controlama per i 2/3 della sua lunghezza.



Sostituzione della controlama

Se la lama e la controlama non s'incrociano più, o se la controlama è troppo danneggiata, vi consigliamo di cambiarla.



Sostituzione dell'ammortizzatore

Se l'attrezzo si chiude troppo di netto alla fine del taglio e il battente è ancora in buono stato, vi consigliamo di sostituire l'ammortizzatore.



Sostituzione del battente

Se l'attrezzo si chiude troppo di netto alla fine del taglio e l'ammortizzatore è ancora in buono stato, è necessario sostituire il battente.



Sostituzione della chiusura

Se la chiusura è danneggiata e si allenta durante l'uso nonostante ne abbiate regolato la vite, sostituirla.



Sostituzione del rivestimento dei manici

Se il rivestimento è troppo danneggiato, potete sostituirlo.

Lasciate il rivestimento a mollo per 2 minuti in acqua bollente – colla consigliata: Loctite 415.